

Rim[®]

NÁVOD K POUŽITÍ
BEDIENUNGSANLEITUNG
OPERATING INSTRUCTIONS
MODE D'EMPLOI
INSTRUKCJA UŻYTKOWANIA
HASZNÁLATI ÚTMUTATÓ

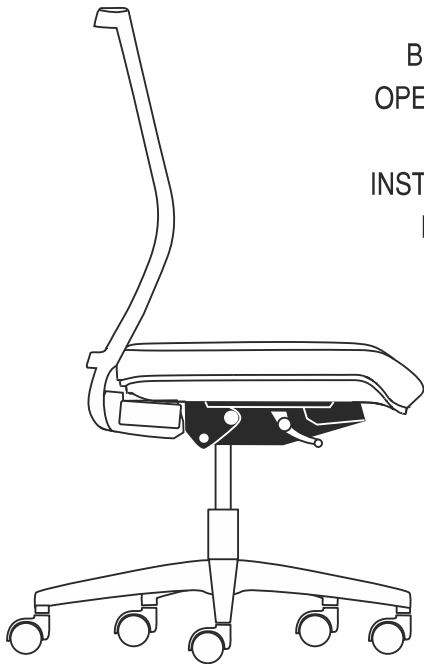

EASY PRO EP 1204
EASY PRO EP 1204L
FOCUS FO 642C
ANATOM AT 985A

SYNCHRO ST1

1

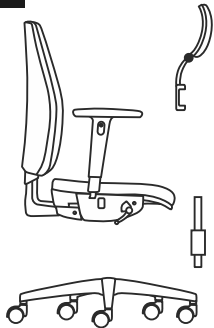

2

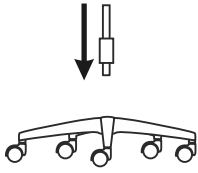

3

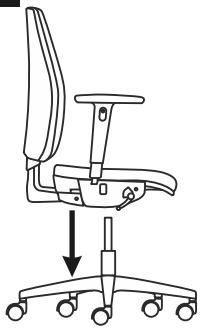

4

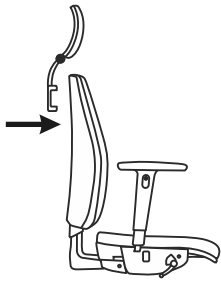

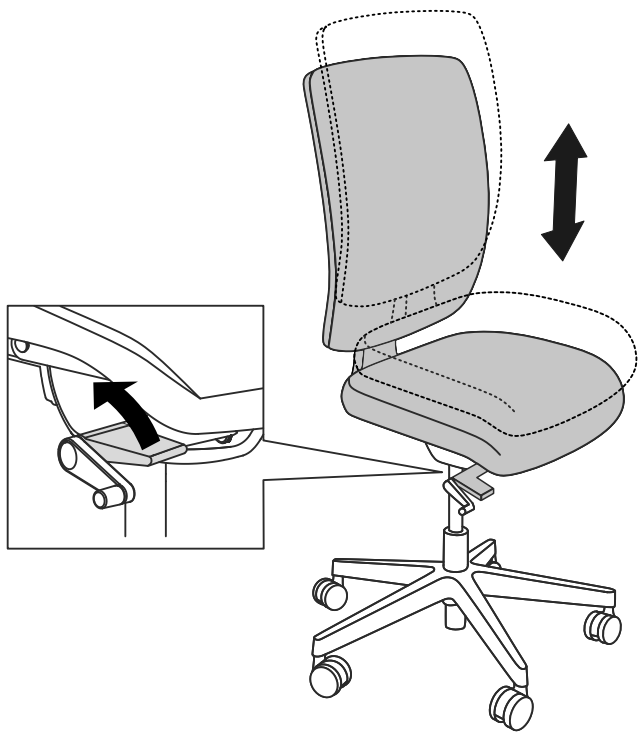

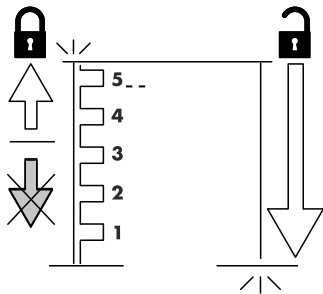
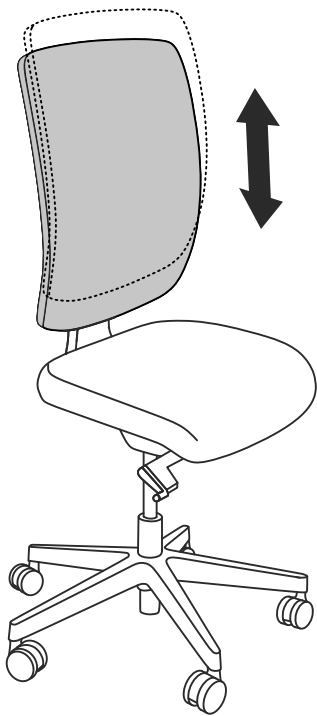

FOCUS FO 642C
ANATOM AT 985A

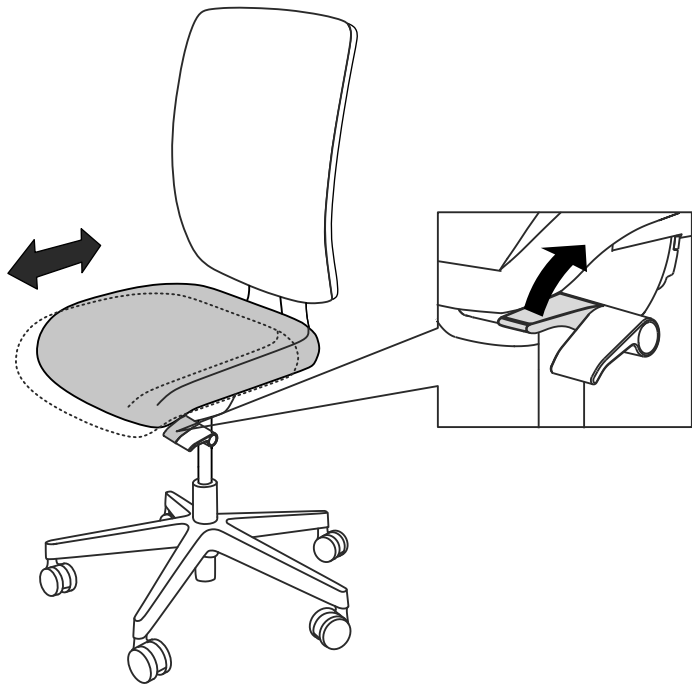

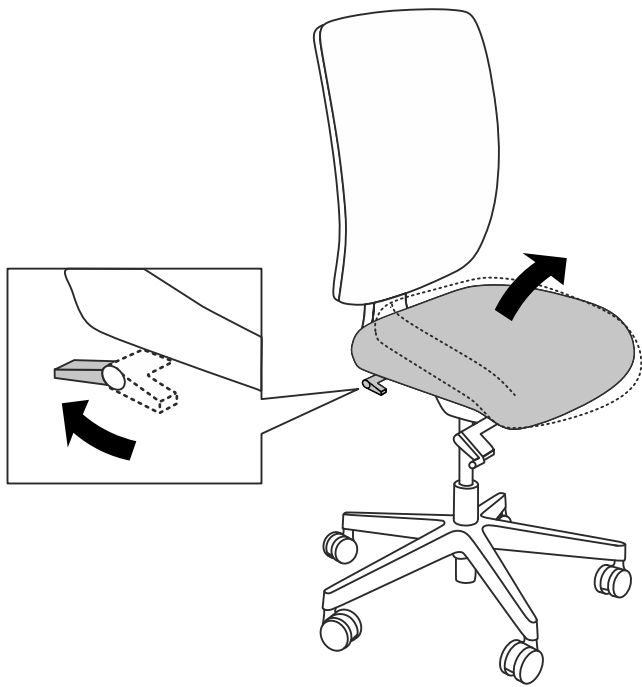

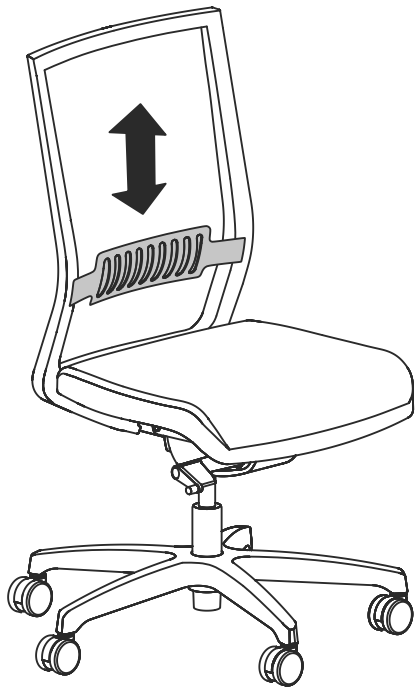

EASY PRO EP 1204
EASY PRO EP 1204L

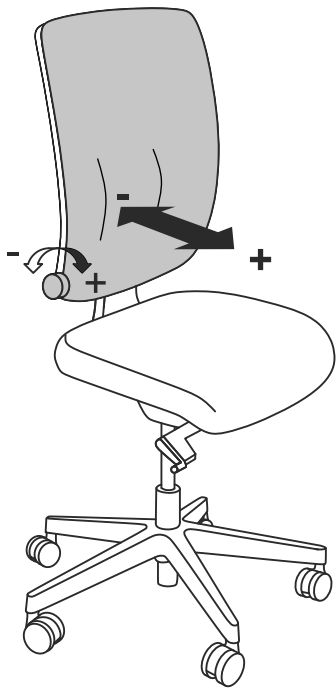

ANATOM AT 985A

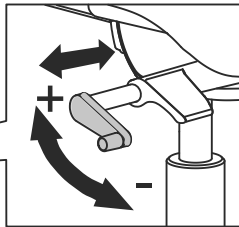
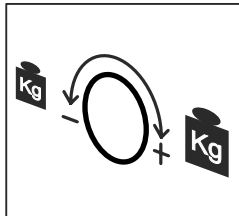
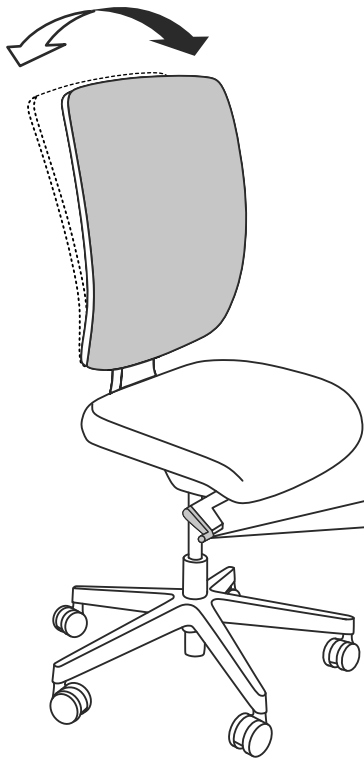

STOP!
STOP!

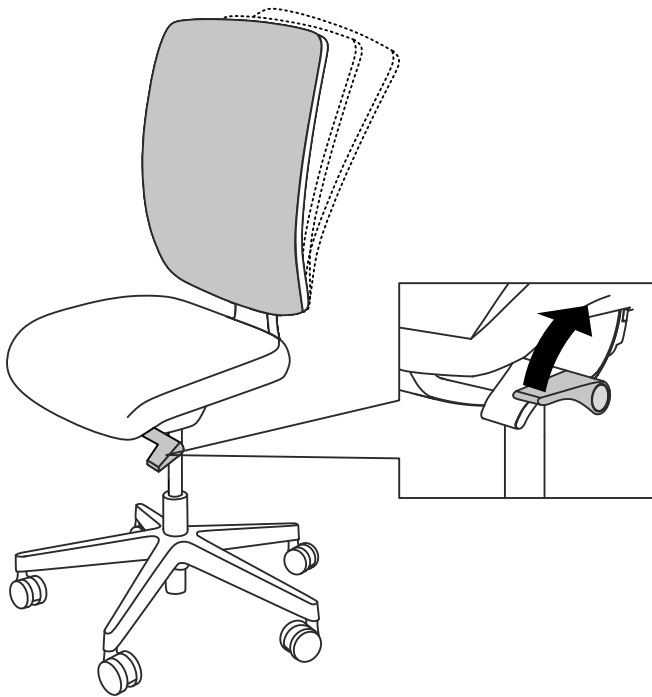

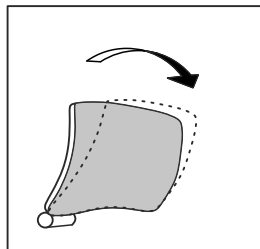
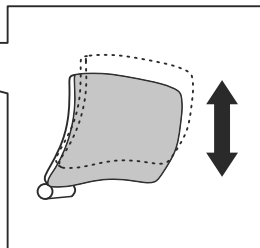
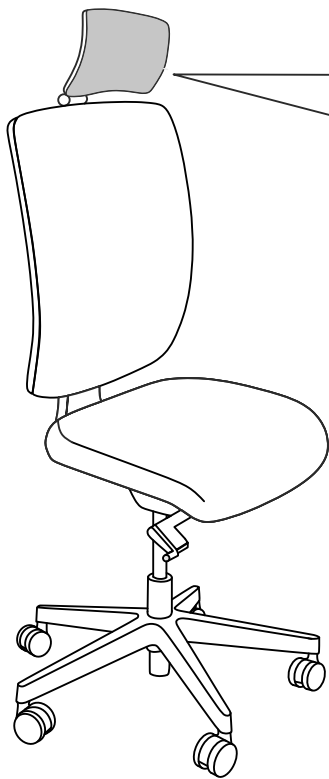

FOCUS FO 642C
ANATOM AT 985A

EASY PRO EP 1204
EASY PRO EP 1204L
FOCUS FO 642C

082 1F

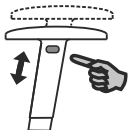

083A 3F

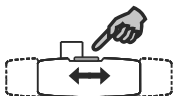
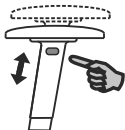

084 4F

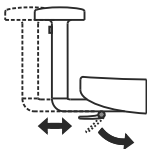
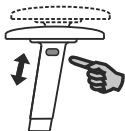

ANATOM AT 985A

082 1F

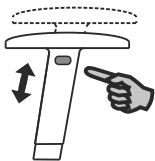

083A 3F

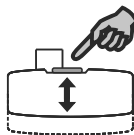
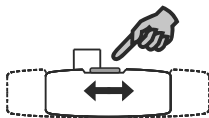
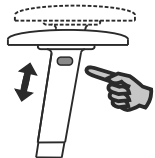

Rim[®]

RIM CZ s.r.o.

Dr. E. Beneše 1015

765 02 Otrokovice

CZECH REPUBLIC

Tel.: +420 577 112 641, -640

Fax: +420 577 101 015

E-mail: info@rim.cz

www.rim.cz

